

evolution



KUBE SERIES

3 DYNAMIC COLOUR LED DISPLAY

THE COLOUR CHANGES DEPENDING ON PROCESS VALUE

CONTROLLERS | PROGRAMMERS

- COMPACT SIZE

- *evoGreen* for energy saving;
- *evoTune* auto-tune PID parameters "push and forget";
- **Universal Input** (TC, mV, V, mA, Pt100-Pt1000 / PTC-NTC);
- **Universal Output** (relay, Vout for SSR, linear mA/V, servomotor);
- **User calibration** for sensor position compensation;
- 8 segments **Programmer** function with "guaranteed soak";
- Independent **Timer** Function with 5 different operating modes;
- Working hours/days **counter** with programmable alarms;
- **Wattmeter** measuring instantaneous/integrated power consumption;
- Parameters sequence **fully customizable**;
- Now with a new white main display for a better visibility (KM line);
- *evoTools* – configuration with codes for quick start-up;
- *evoTools* – programming key for instant parameterisation.

FIELDS OF APPLICATION

- HOT GLUE AND BEADING MACHINES
- WRAPPING, BLISTERING MACHINES
- PAINTING ROOMS
- TEXTILE PRINTING MACHINES
- PACKAGING MACHINERY
- CLIMATIC CHAMBERS AND INCUBATORS
- HOT RUNNER EXTRUDERS
- GLASS BENDING FURNACES
- CONTINUOUS MULTI-ZONE FURNACES
- CERAMIC FURNACES
- SIMPLE CASCADE CONTROLS
- HEAT TREATMENT FURNACES
- FOOTWEAR MACHINERY
- HEAT EXCHANGERS
- INDUSTRIAL BOILERS
- MACHINES FOR LEATHER GOODS

3 COLOUR DISPLAY

The colour of the main display changes depending on process value. Color change thresholds are programmable.

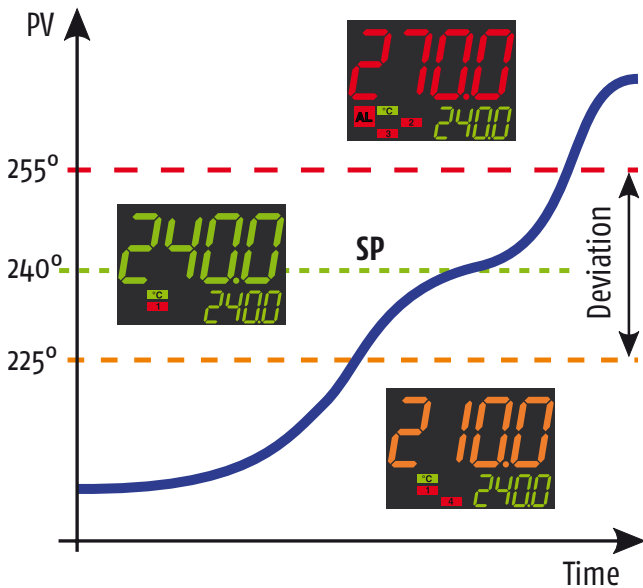

Immediate and intuitive process status acknowledgement, even at great distance.

This function may be disabled by the user.

evoGREEN ENERGY SAVING

This user selectable function allows to reduce energy consumption while indicating the presence of alarms and process deviations, even from a great distance.

Once the function is activated, the display acts as follows:

- If no button is pressed within the user defined time, the display turns off and 4 display segments remain lit and alternate to report that the system is in operation;
- If an alarm is detected or a button is pressed, the display turns on again immediately.



Normal operation



Alarm or operator command

evoTUNE

evoTune is a technological evolution of the “classic” auto-tuning method. Performs auto-tuning in all operating conditions.

At evoTune start-up the instrument evaluates the current situation (set point, current process measurements etc.) and establishes the best tuning solution.

Set point change made during auto-tuning, restarts process according to the new conditions.



evoTOOLS CONFIGURATION CODE

To make a quick and safe instrument configuration, just enter two 4 digit codes.

Input signal type, alarms, control mode and service functions activation will be selected and “ready to use” by pushing a few buttons.

This function does not exclude the full configuration menu, if the application requires it.



cod 1 = 0110

0 1: Type K thermocouple input;
10: Heat PID control, output on OP1,
OP2 = AL1, OP3 = AL2, OP4 = AL3



cod 2 = 1284

1: AL1 Sensor break;
2: AL2 absolute high;
B: AL3 external band alarm;
4: Absolute working time counter (in hours)

CUSTOMIZED PARAMETER SEQUENCE

Provide a user-defined operator interface has been, until now, a privilege of “custom” solutions.

The KUBE Line allows to customize operator parameters making safe and easy the instrument use.

USER CALIBRATION

This function allows the manufacturer of the equipment to **calibrate the entire measurement values** compensating for errors due to:

- Sensor position;
- Sensor accuracy class;
- Accuracy of the instrument.

The "User calibration" **DOES NOT** change factory calibration and can be removed at any time.

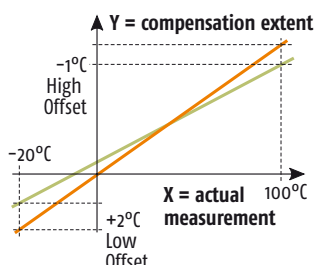

INDEPENDENT TIMER

Timer function with 5 different operating modes.

Programmable time base in h/min, min/s s/thents of seconds.

Start/Hold/Reset command from digital inputs and/or from the button

Function Timer operates in parallel but independently from Control.

PROGRAMMER FUNCTION

This function allows to set:

- Up to 8 segments (4 ramps and 4 soaks);
- 4 start-up modes: at power-up, at power-up with initial delay, on command (from the keyboard, digital input or serial line) and on command signal with initial delay;
- 3 output modes at the end of the program: the process continues with the last programmed set-point, using the last active set-point, switching to stand-by;
- 2 programmable events for each program segment;
- Indicator "program running";
- Timed indicator "program end";
- Two digital inputs and/or the button can be programmed to perform Start/Hold/Reset commands;

Application example:

Paint booth and drying chambers to spray paint (car spray booths).

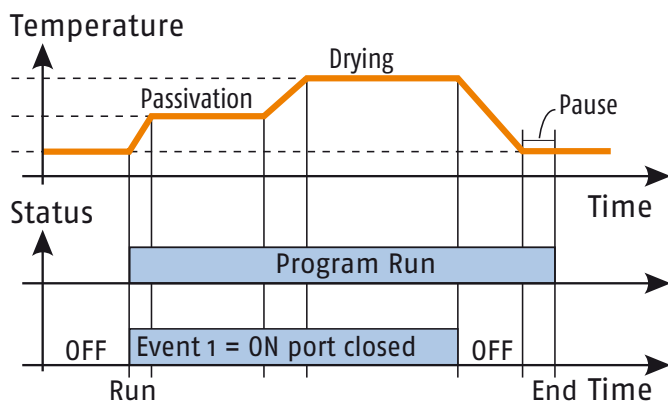

WORKING HOURS/DAYS COUNTER

With adjustable preset

Generates preventive maintenance alerts after a predetermined period of actual operation.

The alert does not interfere with instrument functions and can be reset by maintenance to restart the count.

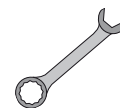

Normal operation

Inspection request

Normal operation

Non resettable

It counts the actual operation period, from its first power-up. Could be used to extend the warranty beyond the legal period. The continuous non-resettable counter provides manufacturer of the machine with a reliable parameter to calculate MTBF (Medium Time Between Failures).

ACCESSORIES

A01 - Programming key

An electronic key, with memory, that can be connected directly to the instrument (even not powered), it provides a variety of functions, including:

- Copy and store the configuration of an instrument (even damaged) and transfer it into another one;
- Configure the instruments in a safe and quick way, without the need of a PC;
- Communicate with a PC, even if the instrument is not equipped with an RS-485 port.



Configuration software

Supplied free of charge, once loaded on PC, allows to:

- Easily configure an instrument;
- Upload and download previously saved configurations;
- Simplify the start-up, thanks to the real time update of variables and parameters.

WinTec - Supervisor

Based on simple and flexible SCADA, it provides:

- Data acquisition;
- Centralized control;
- Alarm and recipes management;
- Trend;
- Report.

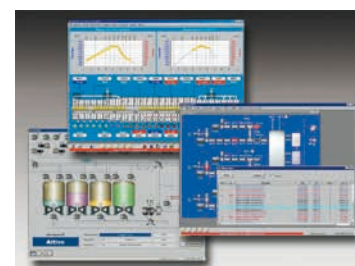



SPECIFICATIONS

DISPLAY		KM1/KR1/KX1	KM3/KR3/KX3
Dual LED	Main display:	4 digit h 10.9 mm (KR) or 15.5 (KM and KX) dynamic three colours red, green and amber or 1 fixed selectable colour or white (KM)	
	Secondary display:	4 digit h 6 mm (KR), 7.6 mm (KM) or 10 mm (KX) green colour	
	Bargraph:	-	22 segments bar graph: (KX models)
INPUTS			
Universal Input	Thermocouples: J (-50... +1000°C/-58... +1832°F), K (-50... +1370°C/-58... +2498°F), S/R (-50... +1760°C/-58... +3200°F), T (-70... +400°C/-94... +752°F) Infrared sensors: J or K RTD: Pt100 3 wires and Pt1000 2 wires (-200... +850°C/-328... +1562°F) Thermistors: PTC KTY81-121 (-50... +150°C/-58... +302°F), NTC 103-AT2 (-50... +110°C/-58... +230°F) Linear signals: 0/12... 60mV, 0/4... 20mA, 0/1... 5V, 0/2...10V		
Measurement accuracy	±0.5% span ±1 digit, (±1% span ±1 digit for T/c type S)		
Digital inputs	1 contact input + 1 (available when I/O 4 = DI2) programmable as voltage (24 VDC) or contact input		
OUTPUTS			
Up to four	OUT1: Relay SPST-NO 4 A/240 Vac (SPDT for KR1) or voltage output for SSR driving 13 V max. @ 1 mA, 10.5 V min. @ 15 mA ±10%		OUT1: Relay SPST-NO 4 A/240 Vac (SPDT for KR3) or voltage output for SSR driving 13 V max. @ 1mA, 10.5 V min. @ 15 mA ±10% or analogue 0/4... 20 mA, 0/2... 10 V galvanically isolated
	OUT2 and OUT3: Relay SPST-NO 2A/240 Vac or voltage output for SSR driving 13 V max. @ 1mA, 10.5 V min. @ 15 mA ±10%		OUT2 and OUT3 (*): Relay SPST-NO 2A/240 Vac or voltage output for SSR driving 13 V max. @ 1mA, 10.5 V min. @ 15 mA ±10% Relay SPST-NO 2A/240 Vac (for servomotor drive)
	OUT4 programmable:	Voltage output for SSR driving 13 V max. @ 1mA, 10.5 V min. @ 22 mA ±10% or transmitter power supply or 2 nd Digital Input	
FUNCTIONAL			
Control	PID single or double action, On/Off, On/Off with Neutral Zone. Autotune, Selftune and <i>ev0</i> Tune. Overshoot control		
Alarms	3 alarms configurable as absolute, deviation, band		
Set Point	4 Set Points selectable		
Serial communications	TTL (standard) + RS485 (optional), protocol: MODBUS RTU		
Communications speed	1200... 38400 baud selectable (8 bit + 1 stop bit, no parity)		
Work hours/days counter	With 2 simultaneous functions: cumulative non-erasable and resettable with alarm		
Power calculation	Instant power, hourly consumption, total consumption during program running		
Evogreen	Time based Display switch-off, selectable		
Programmer (optional)	- -	Up to 8 segments with "guaranteed soak"	
Timer (optional)	Independent with 5 operating modes		
GENERAL			
Power supply	24 Vac/dc ±10%, 100... 240 Vac/dc (-15... +10%), 50/60 Hz, power consumption 7 VA max.		
Temperature	Operating: 0... 50°C (32... 122°F); Storage: -20... +70°C (-4... +158°F);		
Relative humidity	20... 95 RH% with no condensation		
Conformity	EN 61010-1, EN 61326, CE, UKCA, UL		

*: For servomotor drive, both OUT2 and OUT3 are relay output (see "How to order": OUT2 and OUT3 = code M).



KR1 / KR3



Mechanical characteristics

PARAMETER	
Housing	Self-extinguishing plastic UL 94 v0
Mounting	Front panel
Dimensions	78 x 35 x 78 mm (W x H x D)
Panel cut-out	71 x 29 (-0... +0.6 mm)
Weight	140 g approx.
Terminals	24 terminals for cables from 2.5 mm ² (AWG22... AWG14): - on fixed or removable terminal block with screw terminals; - on removable terminal block with spring-load terminals
Protection degree	IP 65 panel mounted with gasket (IP20 for screw terminals) In conformity with En 60070-1 (internal use only)

Electrical connections

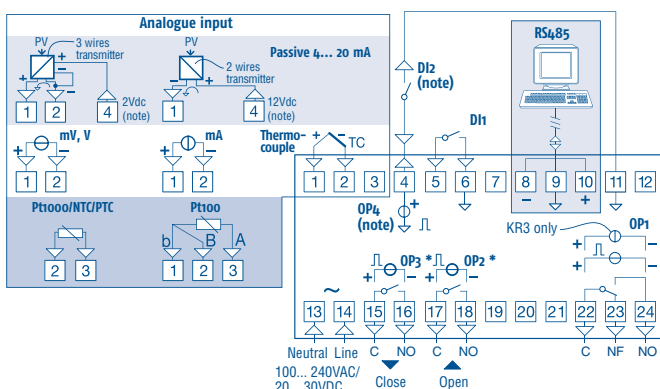

Note: Terminal 4 can be programmed as:
 - **Digital Input (DI2)** connecting a free of voltage contact between terminals 4 and 11
 - **o... 12 V SSR Drive Output (OP4)** connecting the load between terminals 4 and 11
 - **12 Vdc (20 mA) transmitter power supply** connecting the transmitter between terminals 4 and 1

*: For servomotor drive OP2 and OP3 must be ordered as "M". Out 2 (OP2) = open, Out 3 (OP3) = close.

How to order

Model KR1 = Controller KR1T = Controller+ timer KR3 = Controller KR3T = Controller+ timer KR3P = Controller+ timer + programmer
Power supply H = 100... 240 VAC L = 24 VAC/DC
Analogue input + digital input DI1 (standard) C = J, K, R, S, T, PT100, PT 1000 (2 wires), mA, mV, V E = J, K, R, S, T, NTC, PTC, mA, mV, V
Output 1 I = 0/4... 20 mA, 0/2... 10V (KR3 only) R = Relay SPST-NO A4 A (resistive load) O = VDC for SSR
Output 2 - = Not available R = Relay SPST 2 A (resistive load) O = VDC for SSR M = Relay SPST 2 A (servomotor drive KR3 only)*
Output 3 - = Not available R = Relay SPST 2 A (resistive load) O = VDC for SSR M = Relay SPST 2 A (servomotor drive KR3 only)*
Input/Output 4 D = Output 4 (VDC for SSR)/Transmitter PWS/Dig. Input DI2
Serial communication - = TTL Modbus S = RS485 Modbus + TTL Modbus
Connection type - = Standard (non-removable screw terminal block) E = With removable screw terminal block M = With removable spring terminal block N = With removable terminal block (fixed part only)

*: For servomotor drive, both OUT2 and OUT3 codes must be selected as "M".

Dimensions (mm)

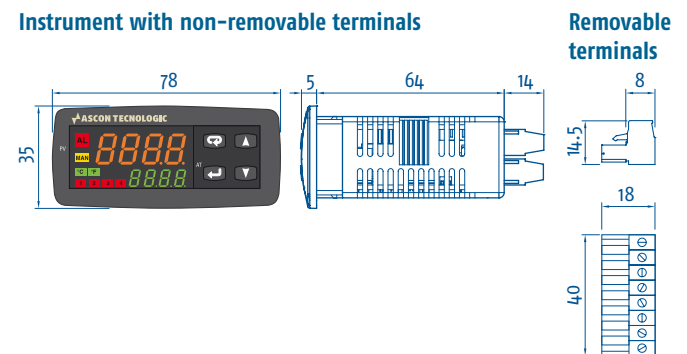



KM1 / KM3



Mechanical characteristics

PARAMETER	
Housing	Self-extinguishing plastic UL 94 v0
Mounting	Front panel
Dimensions	48 x 48 x 62 mm (W x H x D)
Panel cut-out	45 x 45 (-0... +0.6 mm)
Weight	120 g approx.
Terminals	16 terminals for cables from 2.5 mm ² (AWG22... AWG14): - on fixed or removable terminal block with screw terminals; - on removable terminal block with spring-load terminals
Protection degree	IP 65 panel mounted with gasket (IP20 for screw terminals) In conformity with En 60070-1 (internal use only)

Electrical connections

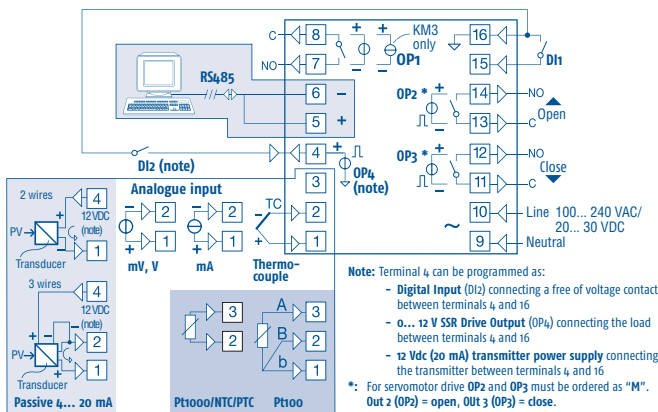

How to order

- Model**
KM1 - = Controller
KM1W = Controller with white display
KM1T = Controller + timer
KM1TW = Controller with white display + timer
KM3 - = Controller
KM3W = Controller with white display
KM3T = Controller + timer
KM3TW = Controller with white display + timer
KM3P = Controller + timer + Programmer
KM3PW = Controller with white display+ timer + Programmer

Power supply
 H = 100... 240 VAC
 L = 24 VAC/DC

Analogue input + digital input DI1 (standard)
 C = J, K, R, S, T, PT100, PT 1000 (2 wires), mA, mV, V
 E = J, K, R, S, T, NTC, PTC, mA, mV, V

Output 1
I = 0/4... 20 mA, 0/2... 10V (**KM3 only**)
R = Relay SPST-NO A4 A (resistive load)
O = VDC for SSR

Output 2
 - = Not available
R = Relay SPST 2 A (resistive load)
O = VDC for SSR
M = Relay SPST 2 A (**servomotor drive KM3 only**)*

Output 3
 - = Not available
R = Relay SPST 2 A (resistive load)
O = VDC for SSR
M = Relay SPST 2 A (**servomotor drive KM3 only**)*

Input/Output 4
D = Output 4 (VDC for SSR)/Transmitter PWS/Dig. Input DI2

Serial communication
 - = TTL Modbus
S = RS485 Modbus + TTL Modbus

Connection type
 - = Standard (non-removable screw terminal block)
E = With removable screw terminal block
M = With removable spring terminal block
N = With removable terminal block (fixed part only)



*: For servomotor drive, both **OUT2** and **OUT3** codes must be selected as "M".

Dimensions (mm)

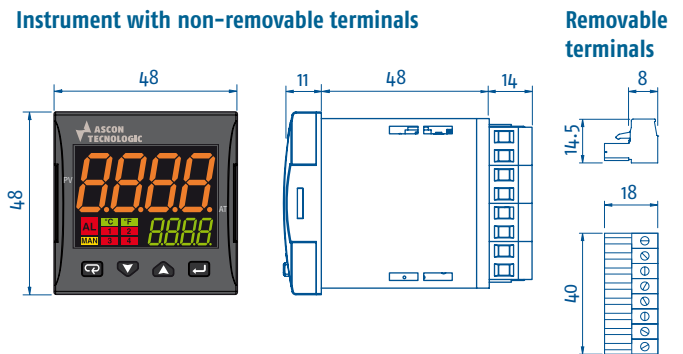



KX1 / KX3



Mechanical characteristics

PARAMETER	
Housing	Self-extinguishing plastic UL 94 v0
Mounting	Front panel
Dimensions	48 x 96 x 75.9 mm (W x H x D)
Panel cut-out	45 x 89 (-0... +0.6 mm)
Weight	160 g approx.
Terminals	16 terminals for cables from 2.5 mm ² (AWG22... AWG14): - on fixed or removable terminal block with screw terminals; - on removable terminal block with spring-load terminals
Protection degree	IP 65 panel mounted with gasket (IP20 for screw terminals) In conformity with En 60070-1 (internal use only)

Electrical connections

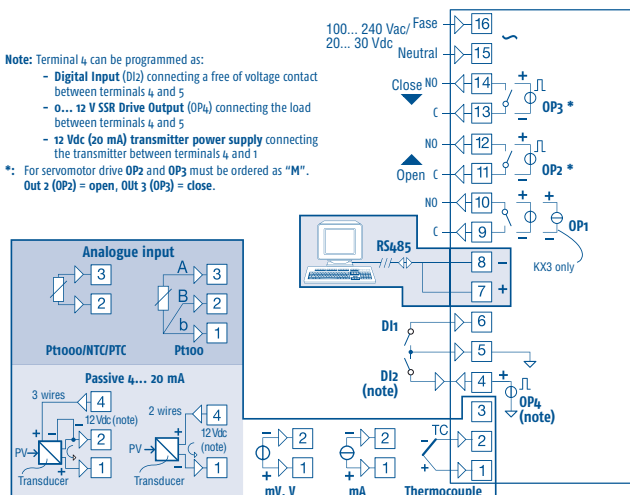

How to order

Model
KX1 - = Controller
KX1T = Controller+ timer
KX3 - = Controller
KX3T = Controller+ timer
KX3P = Controller+ timer + programmer

Power supply
 H = 100... 240 VAC
 L = 24 VAC/DC

Analogue input + digital input DI1 (standard)
 C = J, K, R, S, T, PT100, PT 1000 (2 wires), mA, mV, V
 E = J, K, R, S, T, NTC, PTC, mA, mV, V

Output 1
I = 0/4... 20 mA, 0/2... 10V (**KX3 only**)
R = Relay SPST-NO A4 A (resistive load)
O = VDC for SSR

Output 2
 - = Not available
R = Relay SPST 2 A (resistive load)
O = VDC for SSR
M = Relay SPST 2 A (**servomotor drive KX3 only**)*

Output 3
 - = Not available
R = Relay SPST 2 A (resistive load)
O = VDC for SSR
M = Relay SPST 2 A (**servomotor drive KX3 only**)*

Input/Output 4
D = Output 4 (VDC for SSR)/Transmitter PWS/Dig. Input DI2

Serial communication
 - = TTL Modbus
S = RS485 Modbus + TTL Modbus

Connection type
 - = Standard (non-removable screw terminal block)
E = With removable screw terminal block
M = With removable spring terminal block
N = With removable terminal block (fixed part only)

*: For servomotor drive, both **OUT2** and **OUT3** codes must be selected as "M".

Dimensions (mm)

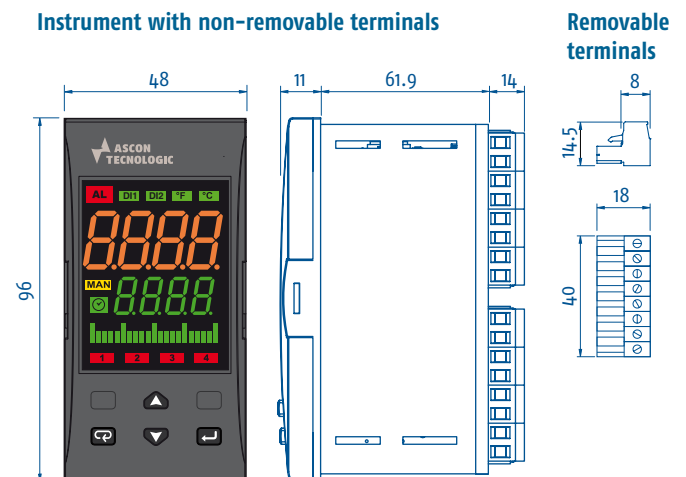

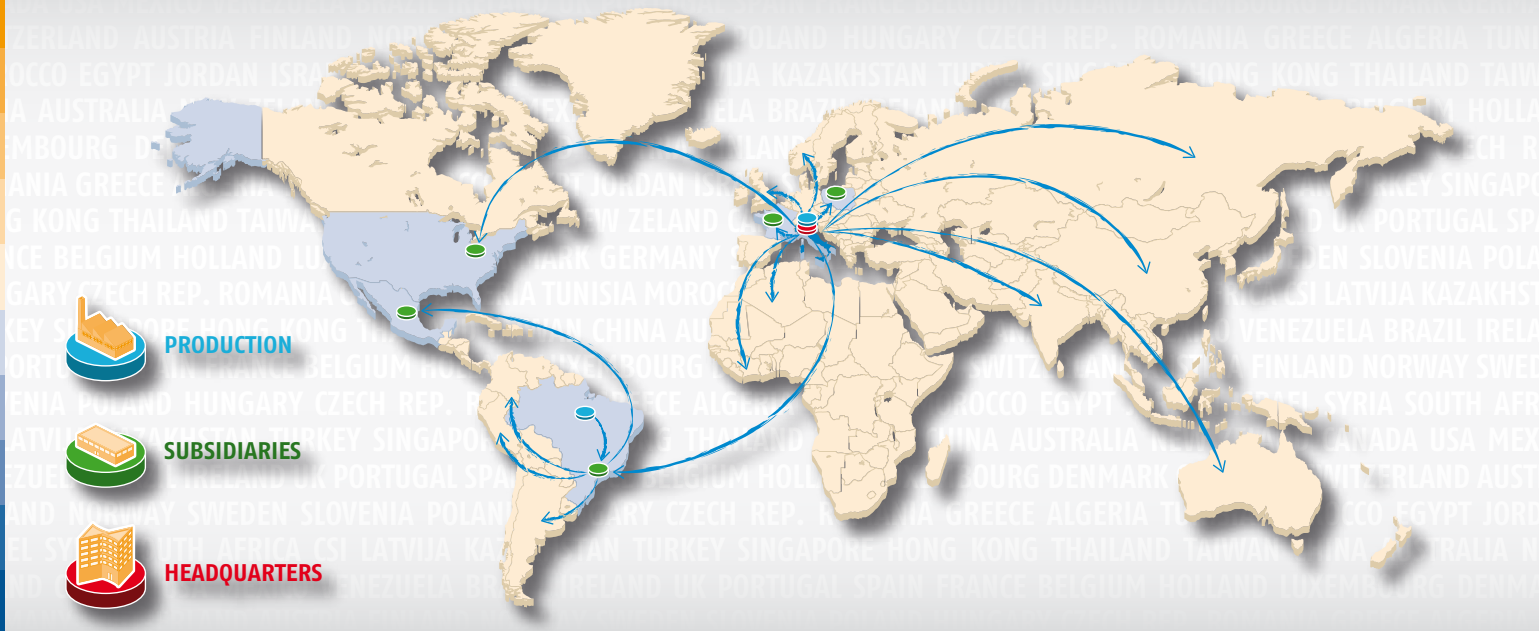

Ascon Tecnologic s.r.l.
viale Indipendenza, 56 · 27029 Vigevano (PV) Italy
tel +39 0381 69 871 · fax +39 0381 69 87 30

info@ascontecnologic.com
www.ascontecnologic.com

Ascon Tecnologic France
BP 76 · 77202 – Marne La Vallee Cedex 1
tel +33 1 64 30 62 62 · fax +33 1 64 30 84 98
info@ascontecnologic.fr
www.ascontecnologic.fr

Ascon Polska Sp. z o.o.
KOCHCICE ul. Kochanowicka 43
42-713 Kochanowice
tel +48 34 35 33 619 · fax +48 34 35 33 884
info@ascon.pl
www.ascon.pl

Ascon Tecnologic – North America
111 Brook Park Road
Cleveland, OH 44109
tel. +1 216 485 8350 ext. 229
info@ascontec-na.com
www.ascontecnologic.com/en

Coelmatic Ltda
Rua Clélia 1810 – Lapa
Sao Paulo · SP – CEP 05042-001- Brazil
tel. +55 11 2066-3211 · fax +55 11 3046-8601
info@coel.com.br
www.coelmatic.com.br

Coelmatic SAPI SA de CV
Dr. Pedro Noriega #1099 – Col Terminal
Monterrey, Nuevo León – CEP 64570
tel. +52 81 8104 1012
info@coelmatic.com.mx
www.coelmatic.com.mx



Distributors and assistance Worldwide. Contact Ascon Tecnologic for more info.